

CAPTOS Toolholders Catalogue



CAPTOS

NEW









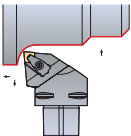
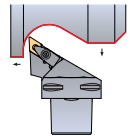
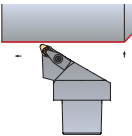
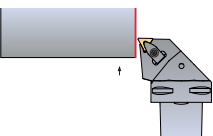
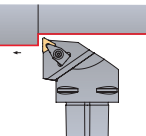
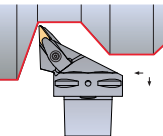
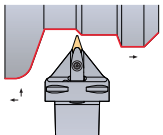
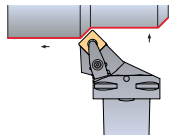
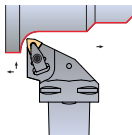





SINCE 1916

(D) DIMPLE LOCK SYSTEM



<p>DCLN 95°</p>  <p>PAGE - 3 4</p> <p>CN.. 0903.. CN.. 1204.. CN.. 1606.. CN.. 1906..</p>	<p>DDJN 93°</p>  <p>PAGE - 5</p> <p>DN.. 1104.. DN.. 1506..</p>	<p>DDJN-DX1 45°</p>  <p>PAGE - 6</p> <p>DOMX 1506..</p>	<p>DTFN 90°</p>  <p>PAGE - 7</p> <p>TN.. 1604.. TN.. 2204..</p>	<p>DTGN 90°</p>  <p>PAGE - 8</p> <p>TNM.. 1604.. TNM.. 2204..</p>	<p>DVJN93°</p>  <p>PAGE - 9</p> <p>VN.. 1604..</p>
<p>DVVN 72°30'</p>  <p>PAGE - 10</p> <p>VN.. 1604..</p>	<p>DSSN 45°</p>  <p>PAGE - 11</p> <p>SNM.. 1204.. SNM.. 1506.. SNM.. 1906..</p>	<p>DWLN 95°</p>  <p>PAGE - 12</p> <p>WNMG.. 0604.. WNMG.. 0806..</p>			

(D) DIMPLE LOCK TOOLHOLDERS

Roughing	Finishing	Medium to Finishing	Medium to Finishing	Medium to Finishing	Medium
Flat  (09-12)	MF  (09-12)	SF  (12)	LC  (12)	GS  (12)	MS  (12)
Medium	Medium	Medium	Medium Wiper	Roughing to Medium	Roughing
MR  (09-12)	PM  (12)	ST  (09-12)	MW  (12)	SS  (09-12)	HR  (12)

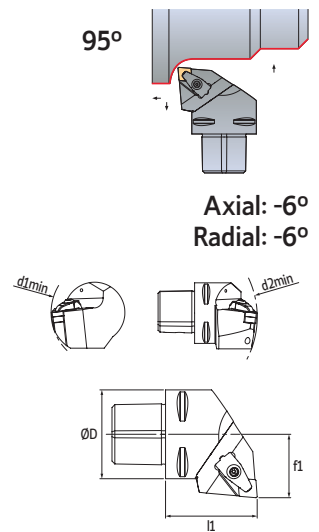



Order Code		Reference	Dimensions (mm)					Insert	Kg	Stock	
R	L		ØD	d1min	d2min	f1	l1			R	L
212432600	212432700	PSC32-DCLN R/L 22040-09	32	60	116	22	40	CN.. 0903..	0,210	○	○
212432800	212432900	PSC40-DCLN R/L 27050-09	40	60	140	27	50	CN.. 0903..	0,420	○	○
212433000	212433100	PSC32-DCLN R/L 22045-12	32	60	121	22	45	CN.. 1204..	0,240	○	○
212433200	212433300	PSC40-DCLN R/L 27050-12	40	110	140	27	50	CN.. 1204..	0,420	○	○
212433400	212433500	PSC50-DCLN R/L3 5060-12	50	110	165	35	60	CN.. 1204..	0,800	○	○
212433600	212433700	PSC63-DCLN R/L 45065-12	63	110	190	45	65	CN.. 1204..	1,100	○	○
212433800	212433900	PSC80-DCLN R/L 55080-12	80	110	250	55	80	CN.. 1204..	2,740	○	○









Stock item | Produto de stock | Itens de stock

Available under request | Disponível sobre consulta | Disponible bajo consulta

SPARE PARTS || Complementos | Repuestos

Cutter Reference	Shim Screw	Shim	Clamp Screw	Clamp	Wrench	Spring	Torque Value
							
PSC32-DCLN R/L 22040-09	T05008000	CC090500	D0500801	GA05001	SS40	M06511	3,5
PSC40-DCLN R/L 27050-09	T05008000	CC090500	D0500801	GA05001	SS40	M06511	3,5
PSC32-DCLN R/L 22045-12	T06010000	CC120600	D0602900	GA07002	SS40	M09513	3,5
PSC40-DCLN R/L 27050-12	T06010000	CC120600	D0602900	GA07002	SS40	M09513	3,5
PSC50-DCLN R/L 35060-12	T06010000	CC120600	D0602900	GA07002	SS40	M09513	3,5
PSC63-DCLN R/L 45065-12	T06010000	CC120600	D0602900	GA07002	SS40	M09513	3,5
PSC80-DCLN R/L 55080-12	T06010000	CC120600	D0602900	GA07002	SS40	M09513	3,5

(D) DIMPLE LOCK TOOLHOLDERS

Roughing	Finishing	Medium	Medium	Roughing to Medium
Flat  (16-19)	MF  (19)	MR  (16-19)	ST  (16-19)	SS  (16-19)
Roughing	Roughing	Heavy to Roughing	Heavy to Roughing	
HR  (16-19)	RP  (16-19)	HY  (19)	HZ  (19)	

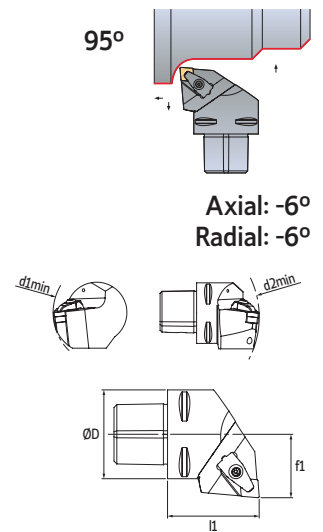

Order Code		Reference	Dimensions (mm)					Insert	Kg	Stock	
R	L		ØD	d1min	d2min	f1	l1			R	L
212434000	212434100	PSC40-DCLN R/L 27055-16	40	125	145	27	55	CN.. 1606..	0,430	○	○
212434200	212434300	PSC50-DCLN R/L 35060-16	50	125	165	35	60	CN.. 1606..	0,800	○	○
212434400	212434500	PSC63-DCLN R/L 45065-16	63	125	190	45	65	CN.. 1606..	1,100	○	○
212434600	212434700	PSC80-DCLN R/L 55080-16	80	125	250	55	80	CN.. 1606..	2,740	○	○
212434800	212434900	PSC50-DCLN R/L 35060-19	50	125	165	35	60	CN.. 1906..	0,800	○	○
212435000	212435100	PSC63-DCLN R/L 45065-19	63	125	190	45	65	CN.. 1906..	1,100	○	○
212435000	212435300	PSC80-DCLNR/L 55080-19	80	125	250	55	80	CN.. 1906..	2,740	○	○

















⊗ Stock item | Produto de stock | Itens de stock

○ Available under request | Disponível sobre consulta | Disponible bajo consulta

SPARE PARTS || Complementos | Repuestos

Cutter Reference	Shim Screw	Shim	Clamp Screw	Clamp	Wrench	Spring	Torque Value
							
PSC40-DCLN R/L 27055-16	T0601575	CC160501	D0602900	GA07004	SS40	M09513	3,5
PSC50-DCLN R/L 35060-16	T0601575	CC160501	D0602900	GA07004	SS40	M09513	3,5
PSC63-DCLN R/L 45065-16	T0601575	CC160501	D0602900	GA07004	SS40	M09513	3,5
PSC80-DCLN R/L 55080-16	T0601575	CC160501	D0602900	GA07004	SS40	M09513	3,5
PSC50-DCLN R/L 35060-19	T06015000	CC190502	D0602900	GA07003	SS40	M09513	3,5
PSC63-DCLN R/L 45065-19	T06015000	CC190502	D0602900	GA07003	SS40	M09513	3,5
PSC80-DCLN R/L 55080-19	T06015000	CC190502	D0602900	GA07003	SS40	M09513	3,5

(D) DIMPLE LOCK TOOLHOLDERS

Roughing	Finishing	Medium to Finishing	Medium to Finishing	Medium	Medium	Medium	Medium
Flat	MF	SF	LC	MS	MR	PM	ST
 (11-15)	 (11-15)	 (11-15)	 (15)	 (15)	 (11-15)	 (15)	 (11-15)
Medium	Medium Wiper	Roughing to Medium	Roughing	Roughing	Roughing to Medium	Medium to Finishing	Medium to Finishing
GS	MW	SS	HR	RP	O1	O2	O3
 (11-15)	 (15)	 (11-15)	 (15)	 (15)	 (15)	 (15)	 (15)

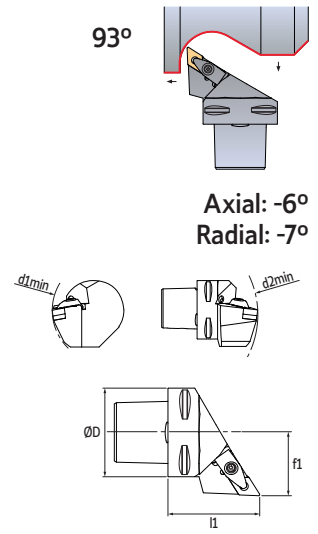

Order Code		Reference	Dimensions (mm)					Insert	Kg	Stock	
R	L		ØD	d1min	d2min	f1	l1			R	L
212435400	212435500	PSC32-DDJN R/L 22045-11	32	60	121	22	45	DN.. 1104..	0,240	○	○
212435600	212435700	PSC40-DDJN R/L 27050-11	40	60	140	27	50	DN.. 1104..	0,420	○	○
212435800	212435900	PSC50-DDJN R/L 35060-11	50	65	165	35	60	DN.. 1104..	0,800	○	○
212436000	212436100	PSC63-DDJN R/L 45065-11	63	81	190	45	65	DN.. 1104..	1,100	○	○
212436200	212436300	PSC40-DDJN R/L 27055-15	40	110	145	27	55	DN.. 1506..	0,420	⊗	⊗
212436400	212436500	PSC50-DDJN R/L 35060-15	50	110	165	35	60	DN.. 1506..	0,800	⊗	⊗
212436600	212436700	PSC63-DDJN R/L 45065-15	63	110	190	45	65	DN.. 1506..	1,100	⊗	⊗
212436800	212436900	PSC80-DDJN R/L 55080-15	80	110	250	55	80	DN.. 1506..	2,740	⊗	⊗

⊗ Stock item | Produto de stock | Itens de stock



○ Available under request | Disponível sobre consulta | Disponible bajo consulta

SPARE PARTS | Complementos | Repuestos

Cutter Reference	Shim Screw	Shim	Clamp Screw	Clamp	Wrench	Spring	Torque Value
							
PSC32-DDJN R/L 22045-11	T05008000	CD110302	D0500801	GA05001	SS40	M06511	3,5
PSC40-DDJN R/L 27050-11	T05008000	CD110302	D0500801	GA05001	SS40	M06511	3,5
PSC50-DDJN R/L 35060-11	T05008000	CD110302	D0500801	GA05001	SS40	M06511	3,5
PSC63-DDJN R/L 45065-11	T05008000	CD110302	D0500801	GA05001	SS40	M06511	3,5
PSC40-DDJN R/L 27055-15	T06010000	CD150501	D0602900	GA07002	SS40	M09513	3,5
PSC50-DDJN R/L 35060-15	T06010000	CD150501	D0602900	GA07002	SS40	M09513	3,5
PSC63-DDJN R/L 45065-15	T06010000	CD150501	D0602900	GA07002	SS40	M09513	3,5
PSC80-DDJN R/L 55080-15	T06010000	CD150501	D0602900	GA07002	SS40	M09513	3,5

DDJN-DX1 45° | TOOLHOLDERS | Ferros de torno | Herramientas de torneado





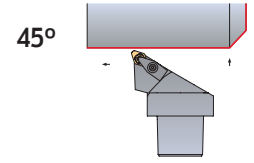

(D) DIMPLE LOCK TOOLHOLDERS

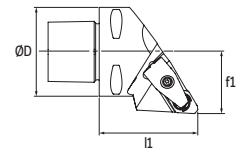
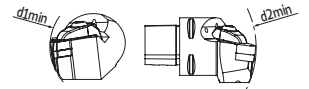
Roughing to Heavy Roughing	Roughing to Heavy Roughing
DOMX (L1)	DOMX (R1)
	
(15)	(15)



Axial: -6°
Radial: -7°









Order Code		Reference	Dimensions (mm)					Insert	Kg	Stock	
R	L		ØD	d1min	d2min	f1	l1			R	L
182000100	182000500	PSC40-DDJN R/L 27055-15-DX1	40	110	145	27	55	DOMX 1506..	0,42		
182000200	182000600	PSC50-DDJN R/L 35060-15-DX1	50	110	165	35	60	DOMX 1506..	0,80		
182000300	182000700	PSC63-DDJN R/L 45065-15-DX1	63	110	190	45	65	DOMX 1506..	1,10		
182000400	182000800	PSC80-DDJN R/L 55080-15-DX1	80	110	250	55	80	DOMX 1506..	2,74		

 Stock item | Produto de stock | Itens de stock













 Available under request | Disponível sobre consulta | Disponible bajo consulta

SPARE PARTS | Complementos | Repuestos

Cutter Reference	Shim R	Shim L	Shim Screw	Spring	Clamp	Clamp Screw	Wrench
							
PSC40-DDJN R/L 27055-15-DX1	CD150503	CD150502	T06010000	M09513	GA07002	D0602900	SS40
PSC50-DDJN R/L 35060-15-DX1	CD150503	CD150502	T06010000	M09513	GA07002	D0602900	SS40
PSC63-DDJN R/L 45065-15-DX1	CD150503	CD150502	T06010000	M09513	GA07002	D0602900	SS40
PSC80-DDJN R/L 55080-15-DX1	CD150503	CD150502	T06010000	M09513	GA07002	D0602900	SS40

DTFN 90° | TOOLHOLDERS | Ferros de torno | Herramientas de torneado

(D) DIMPLE LOCK TOOLHOLDERS

Roughing	Finishing	Medium to Finishing	Medium to Finishing	Medium	Medium to Finishing
Flat	MF	SF	LC	MS	GS
 (16-22)	 (16-22)	 (16-22)	 (16-22)	 (16)	 (16)
Medium	Medium	Medium	Roughing to Medium	Roughing	Medium to Finishing
MR	PM	ST	SS	HR	O1
 (16-22)	 (16-22)	 (16-22)	 (16-22)	 (16-22)	 (16)

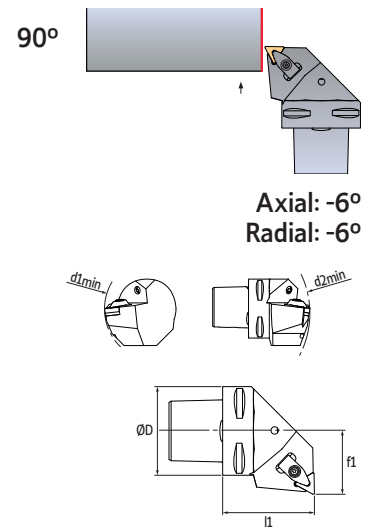

Order Code		Reference	Dimensions (mm)					Insert	Kg	Stock	
R	L		ØD	d1min	d2min	f1	l1			R	L
212439000	212439100	PSC40-DTFN R/L 27050-16	40	110	140	27	50	TNM.. 1604..	0,420	○	○
212439200	212439300	PSC50-DTFN R/L 35060-16	50	110	165	35	60	TNM.. 1604..	0,800	○	○
212439400	212439500	PSC63-DTFN R/L 45065-16	63	110	190	45	65	TNM.. 1604..	1,100	○	○
212439600	212439700	PSC40-DTFN R/L 27050-22	40	110	140	27	50	TNM.. 2204..	0,420	○	○
212439800	212439900	PSC50-DTFN R/L 35060-22	50	110	165	35	60	TNM.. 2204..	0,800	○	○
212440000	212440100	PSC63-DTFN R/L 45065-22	63	110	190	45	65	TNM.. 2204..	1,100	○	○











📦 Stock item | Produto de stock | Itens de stock

○ Available under request | Disponível sobre consulta | Disponible bajo consulta

SPARE PARTS | Complementos | Repuestos

Cutter Reference	Shim Screw	Shim	Clamp Screw	Clamp	Wrench	Spring	Torque Value
							
PSC40-DTFN R/L 27050-16	T05008000	CT160600	D0500801	GA05001	SS40	M06511	3,5
PSC50-DTFN R/L 35060-16	T05008000	CT160600	D0500801	GA05001	SS40	M06511	3,5
PSC63-DTFN R/L 45065-16	T05008000	CT160600	D0500801	GA05001	SS40	M06511	3,5
PSC40-DTFN R/L 27050-22	T06010000	CT220500	D0602900	GA07002	SS40	M09513	3,5
PSC50-DTFN R/L 35060-22	T06010000	CT220500	D0602900	GA07002	SS40	M09513	3,5
PSC63-DTFN R/L 45065-22	T06010000	CT220500	D0602900	GA07002	SS40	M09513	3,5

(D) DIMPLE LOCK TOOLHOLDERS

Roughing	Finishing	Medium to Finishing	Medium to Finishing	Medium	Medium
Flat  (16-22)	MF  (16-22)	SF  (16-22)	LC  (16-22)	MS  (16)	MR  (16-22)
Medium	Medium	Roughing to Medium	Roughing	Medium to Finishing	
PM  (16-22)	ST  (16-22)	SS  (16-22)	HR  (16-22)	O1  (16)	

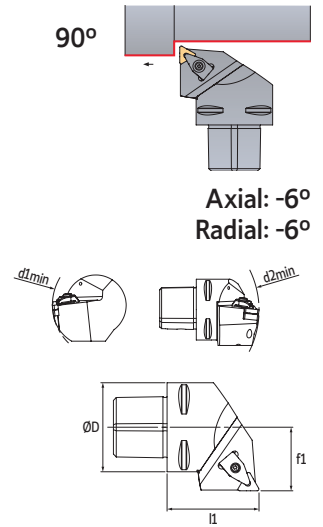

Order Code		Reference	Dimensions (mm)					Insert	Kg	Stock	
R	L		ØD	d1min	d2min	f1	l1			R	L
212440200	212440300	PSC40-DTGN R/L 27050-16	40	110	140	27	50	TNM.. 1604..	0,420	○	○
212440400	212440500	PSC50-DTGN R/L 35060-16	50	110	165	35	60	TNM.. 1604..	0,800	○	○
212440600	212440700	PSC63-DTGN R/L 45065-16	63	110	190	45	65	TNM.. 1604..	1,100	○	○
212440800	212440900	PSC40-DTGN R/L 27050-22	40	110	140	27	50	TNM.. 2204..	0,420	○	○
212441000	212441100	PSC50-DTGN R/L 35060-22	50	110	165	35	60	TNM.. 2204..	0,800	○	○
212441200	212441300	PSC63-DTGN R/L 45065-22	63	110	190	45	65	TNM.. 2204..	1,100	○	○







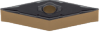

📦 Stock item | Produto de stock | Itens de stock

○ Available under request | Disponível sobre consulta | Disponible bajo consulta

SPARE PARTS || Complementos | Repuestos

Cutter Reference	Shim Screw	Shim	Clamp Screw	Clamp	Wrench	Spring	Torque Value
							
PSC40-DTGN R/L 27050-16	T05008000	CT160600	D0500801	GA05001	SS40	M06511	3,5
PSC50-DTGN R/L 35060-16	T05008000	CT160600	D0500801	GA05001	SS40	M06511	3,5
PSC63-DTGN R/L 45065-16	T05008000	CT160600	D0500801	GA05001	SS40	M06511	3,5
PSC40-DTGN R/L 27050-22	T06010000	CT220500	D0602900	GA07002	SS40	M09513	3,5
PSC50-DTGN R/L 35060-22	T06010000	CT220500	D0602900	GA07002	SS40	M09513	3,5
PSC63-DTGN R/L 45065-22	T06010000	CT220500	D0602900	GA07002	SS40	M09513	3,5

(D) DIMPLE LOCK TOOLHOLDERS

Roughing	Medium to Finishing	Medium to Finishing	Medium to Finishing	Medium to Finishing
Flat	MF	SF	LC	MS
 (16)	 (16)	 (16)	 (16)	 (16)
Medium to Finishing	Medium	Medium	Medium	Roughing to Medium
GS	MR	PM	ST	SS
 (16)	 (16)	 (16)	 (16)	 (16)

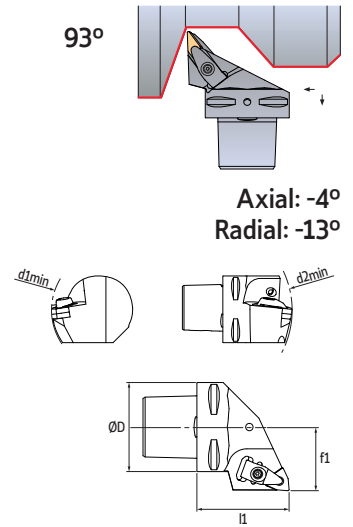







Order Code		Reference	Dimensions (mm)					Insert	Kg	Stock	
R	L		ØD	d1min	d2min	f1	l1			R	L
212441400	212441500	PSC40-DVJN R/L 27062-16	40	60	152	27	62	VN.. 1604..	0,450	○	○
212441600	212441700	PSC50-DVJN R/L 35065-16	50	65	170	35	65	VN.. 1604..	0,790	○	○
212441800	212441900	PSC63-DVJN R/L 45065-16	63	81	190	45	65	VN.. 1604..	1,100	○	○
212442000	212442100	PSC80-DVJN R/L 55080-16	80	100	250	55	80	VN.. 1604..	2,740	○	○

 Stock item | Produto de stock | Itens de stock











 Available under request | Disponível sobre consulta | Disponible bajo consulta

SPARE PARTS | Complementos | Repuestos

Cutter Reference	Shim Screw	Shim	Clamp Screw	Clamp	Wrench	Spring	Torque Value
							
PSC40-DVJN R/L 27062-16	T05008000	CV160301	D0500801	GA05001	SS40	M06511	3,5
PSC50-DVJN R/L 35065-16	T05008000	CV160301	D0500801	GA05001	SS40	M06511	3,5
PSC63-DVJN R/L 45065-16	T05008000	CV160301	D0500801	GA05001	SS40	M06511	3,5
PSC80-DVJN R/L 55080-16	T05008000	CV160301	D0500801	GA05001	SS40	M06511	3,5

DVVN 72°30' || TOOLHOLDERS | Ferros de torno | Herramientas de torneado

(D) DIMPLE LOCK TOOLHOLDERS

Roughing	Medium to Finishing	Medium to Finishing	Medium to Finishing	Medium to Finishing
Flat  (16)	MF  (16)	SF  (16)	LC  (16)	MS  (16)
Medium to Finishing	Medium	Medium	Medium	Roughing to Medium
GS  (16)	MR  (16)	PM  (16)	ST  (16)	SS  (16)

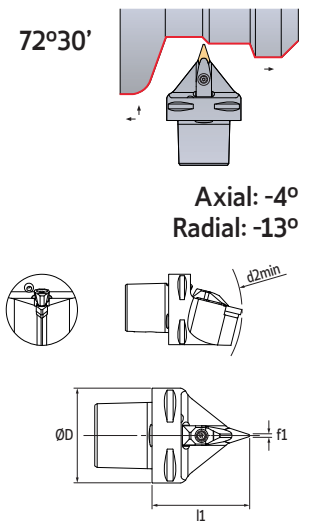







Order Code	Reference	Dimensions (mm)				Insert	Kg	Stock	
		ØD	d2min	f1	l1			R	L
212442200	PSC40-DVVNN 00062-16	40	152	0,6	62	VN.. 1604..	0,430	○	○
212442300	PSC50-DVVNN 00065-16	50	170	0,6	65	VN.. 1604..	0,800	○	○
212442400	PSC63-DVVNN 00065-16	63	190	0,6	65	VN.. 1604..	1,070	○	○
212442500	PSC80-DVVNN 00080-16	80	250	0,6	80	VN.. 1604..	2,320	○	○













 Stock item | Produto de stock | Itens de stock

 Available under request | Disponível sobre consulta | Disponible bajo consulta

SPARE PARTS || Complementos | Repuestos

Cutter Reference	Shim Screw	Shim	Clamp Screw	Clamp	Wrench	Spring	Torque Value
							
PSC40-DVVNN 00062-16	T05008000	CV160301	D0500801	GA05001	SS40	M06511	3,5
PSC50-DVVNN 00065-16	T05008000	CV160301	D0500801	GA05001	SS40	M06511	3,5
PSC63-DVVNN 00065-16	T05008000	CV160301	D0500801	GA05001	SS40	M06511	3,5
PSC80-DVVNN 00080-16	T05008000	CV160301	D0500801	GA05001	SS40	M06511	3,5

(D) DIMPLE LOCK TOOLHOLDERS

Roughing	Finishing	Medium	Medium to Finishing	Medium	Medium
Flat  (12-19)	MF  (12)	SF  (12)	GS  (12)	MR  (12-19)	PM  (12)
Medium	Roughing to Medium	Roughing	Roughing	Heavy to Roughing	Heavy to Roughing
ST  (12-19)	SS  (12-19)	HR  (12-19)	RP  (19)	HY  (19)	HZ  (19)

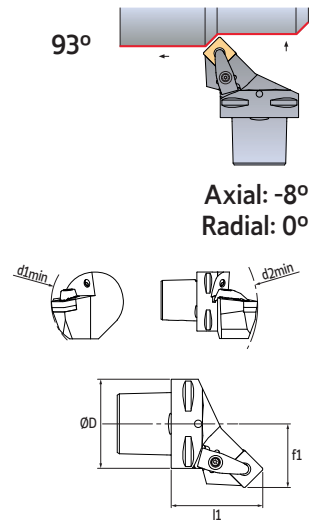







Order Code		Reference	Dimensions (mm)					Insert	Kg	Stock	
R	L		ØD	d1min	d2min	f1	l1			R	L
212437000	212437100	PSC32-DSSN R/L 22040-12	32	60	124	22	40	SNM.. 1204..	0,210	○	○
212437200	212437300	PSC40-DSSN R/L 27042-12	40	110	140	27	42	SNM.. 1204..	0,350	○	○
212437400	212437500	PSC50-DSSN R/L 35052-12	50	110	165	35	52	SNM.. 1204..	0,700	○	○
212437600	212437700	PSC63-DSSN R/L 45056-12	63	110	190	45	56	SNM.. 1204..	1,120	○	○
212437800	212437900	PSC40-DSSN R/L 27045-15	40	125	145	27	45	SNM.. 1506..	0,400	○	○
212438000	212438100	PSC50-DSSN R/L 35050-15	50	125	165	35	50	SNM.. 1506..	0,680	○	○
212438200	212438300	PSC63-DSSN R/L 45054-15	63	125	190	45	54	SNM.. 1506..	1,140	○	○
212438400	212438500	PSC50-DSSN R/L 35048-19	50	125	165	35	48	SNM.. 1906..	0,700	○	○
212438600	212438700	PSC63-DSSN R/L 45052-19	63	125	190	45	52	SNM.. 1906..	1,130	○	○













⊗ Stock item | Produto de stock | Itens de stock

○ Available under request | Disponível sobre consulta | Disponible bajo consulta

SPARE PARTS | Complementos | Repuestos

Cutter Reference	Shim Screw	Shim	Clamp Screw	Clamp	Wrench	Spring	Torque Value
							
PSC32-DSSN R/L 22040-12	T06010000	CS120600	D0602900	GA07002	SS40	M09513	3,5
PSC40-DSSN R/L 27042-12	T06010000	CS120600	D0602900	GA07002	SS40	M09513	3,5
PSC50-DSSN R/L 35052-12	T06010000	CS120600	D0602900	GA07002	SS40	M09513	3,5
PSC63-DSSN R/L 45056-12	T06010000	CS120600	D0602900	GA07002	SS40	M09513	3,5
PSC40-DSSN R/L 27045-15	T0601575	CS150500	D0602900	GA07004	SS40	M09513	3,5
PSC50-DSSN R/L 35050-15	T0601575	CS150500	D0602900	GA07004	SS40	M09513	3,5
PSC63-DSSN R/L 45054-15	T0601575	CS150500	D0602900	GA07004	SS40	M09513	3,5
PSC50-DSSN R/L 35048-19	T06015000	CS190501	D0602900	GA07003	SS40	M09513	3,5
PSC63-DSSN R/L 45052-19	T06015000	CS190501	D0602900	GA07003	SS40	M09513	3,5

(D) DIMPLE LOCK TOOLHOLDERS

Roughing	Finishing	Medium to Finishing	Medium to Finishing	Medium to Finishing	Medium to Finishing
Flat  (06-08)	MF  (06-08)	SF  (06-08)	LC  (08)	MS  (06-08)	GS  (06-08)
Medium	Medium	Medium	Medium Wiper	Roughing to Medium	Roughing
PM  (06-08)	MR  (06-08)	ST  (08)	MW  (06-08)	SS  (06-08)	HR  (08)

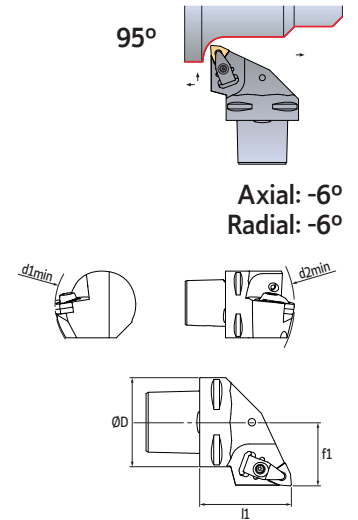

Order Code		Reference	Dimensions (mm)					Insert	Kg	Stock	
R	L		$\varnothing D$	d_{1min}	d_{2min}	f_1	l_1			R	L
212442600	212442700	PSC32-DWLN R/L 22040-06	32	60	116	22	40	WNMG 0604..	0,210	○	○
212442800	212442900	PSC40-DWLN R/L 27050-06	40	60	140	27	50	WNMG 0604..	0,420	○	○
212443000	212443100	PSC50-DWLN R/L 35060-06	50	65	165	35	60	WNMG 0604..	0,800	○	○
212443200	212443300	PSC63-DWLN R/L 45065-06	63	81	190	45	65	WNMG 0604..	1,100	○	○
212443400	212443500	PSC40-DWLN R/L 27050-08	40	110	140	27	50	WNMG 0804..	0,420	○	○
212443600	212443700	PSC50-DWLN R/L 35060-08	50	110	165	35	60	WNMG 0804..	0,800	○	○
212443800	212443900	PSC63-DWLN R/L 45065-08	63	110	190	45	65	WNMG 0804..	1,100	○	○
212444000	212444100	PSC80-DWLN R/L 55080-08	80	110	250	55	80	WNMG 0804..	2,740	○	○

📦 Stock item | Produto de stock | Itens de stock

○ Available under request | Disponível sobre consulta | Disponible bajo consulta



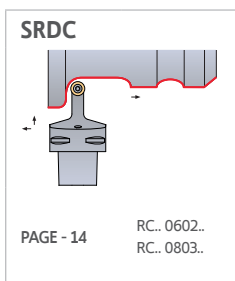
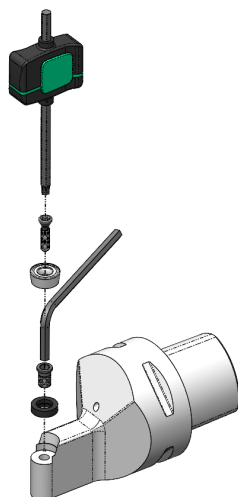

SPARE PARTS | Complementos | Repuestos

Cutter Reference	Shim Screw	Shim	Clamp Screw	Clamp	Wrench	Spring	Torque Value
							
PSC32-DWLN R/L 22040-06	T05008000	CW060302	D0500801	GA05001	SS40	M06511	3,5
PSC40-DWLN R/L 27050-06	T05008000	CW060302	D0500801	GA05001	SS40	M06511	3,5
PSC50-DWLN R/L 35060-06	T05008000	CW060302	D0500801	GA05001	SS40	M06511	3,5
PSC63-DWLN R/L 45065-06	T05008000	CW060302	D0500801	GA05001	SS40	M06511	3,5
PSC40-DWLN R/L 27050-08	T06010000	CW080500	D0602900	GA07002	SS40	M09513	3,5
PSC50-DWLN R/L 35060-08	T06010000	CW080500	D0602900	GA07002	SS40	M09513	3,5
PSC63-DWLN R/L 45065-08	T06010000	CW080500	D0602900	GA07002	SS40	M09513	3,5
PSC80-DWLN R/L 55080-08	T06010000	CW080500	D0602900	GA07002	SS40	M09513	3,5

(S) CENTER SCREW SYSTEM



(S) CENTER SCREW TOOLHOLDERS

Medium	Medium to Finishing	Roughing to Medium	Finishing to Fine Finishing
CP  (06)	GS  (08)	..MT-ST  (08)	LN  (06-08)

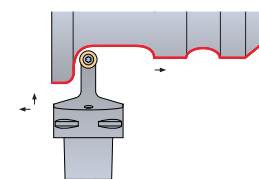

Axial: 0°
Radial: 0°

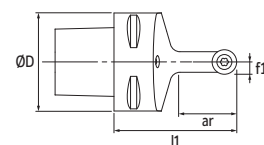
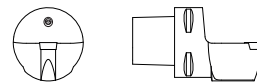



Order Code	Reference	Dimensions (mm)				Insert	Kg	Stock	
		ØD	f1	l1	ar			R	L
212444300	PSC32-SRDC N 00040-06	32	3	40	12	RC.. 0602..	0,160	○	○
212462200	PSC40-SRDC N 00050-06	40	3	50	12	RC.. 0602..	0,350	○	○
212462300	PSC50-SRDC N 00060-06	50	3	60	12	RC.. 0602..	0,750	○	○
212462400	PSC32-SRDC N 00040-08	32	4	40	16	RC.. 0803..	0,160	○	○
212470900	PSC40-SRDC N00050-08	40	4	50	16	RC.. 0803..	0,35	○	○
212471000	PSC50-SRDC N00060-08	50	4	60	16	RC.. 0803..	0,35	○	○

⊗ Stock item | Produto de stock | Itens de stock

○ Available under request | Disponível sobre consulta | Disponible bajo consulta

SPARE PARTS || Complementos | Repuestos

Cutter Reference	Shim Screw	Wrench	Torque Value
			
PSC32-SRDC N 00040-06	P0250700	XT07	0,9
PSC40-SRDC N 00050-06	P0250700	XT07	0,9
PSC50-SRDC N 00060-06	P0250700	XT07	0,9
PSC32-SRDC N 00040-08	P0300900	XT08	1,2
PSC40-SRDC N 00050-08	P0300900	XT08	1,2
PSC50-SRDC N 00060-08	P0300900	XT08	1,2

SPARE PARTS

CLAMPS (D HOLDERS) | Grampos (Suportes D) | Bidas (Soportes D)

GA05001
290082000

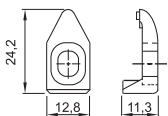
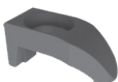

GA07002
290082100

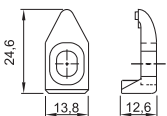
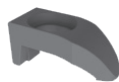

GA07003
290082200

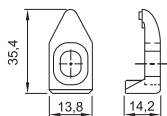

GA07004
290085600

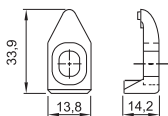
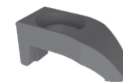

SCREWS (ALLEN) | Parafusos (Allen) | Tornillos (Allen)

T05008000
290082300
Allen 2

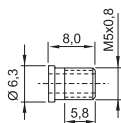

T06010000
290082400
Allen 2.5

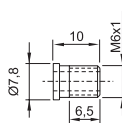

T06015000
290082500
Allen 3

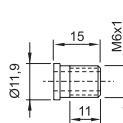

T0601575
290085500
Allen 3

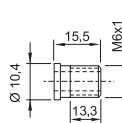

D0500801
290082700
Allen 5

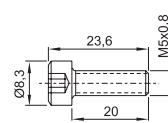

D0602900
290082900
Allen 4

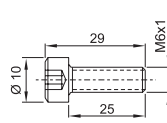

SCREWS (TORX) | Parafusos (torx) | Tornillos (torx)

P0250700
290013400
Torx T-7

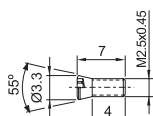

SHIMS (C SHAPES) | Colchões (Pastilhas C) | Placas Base (Plaquitás C)

CC190500
212169300

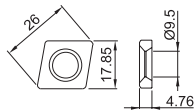

CC120600
290083200

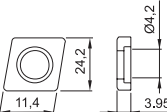

CC190502
290073200

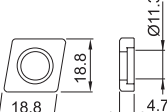

CC160501
290085400

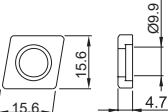

SHIMS (D SHAPES) | Colchões (Pastilhas D) | Placas Base (Plaquitás D)

CD110302
290083400

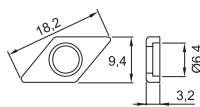

CD150501
290073300

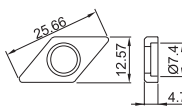

CD150502
116021623

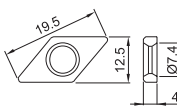

CD150503
116021723

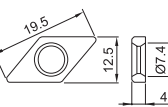

SPARE PARTS

SHIMS (S SHAPES) | Colchões (Pastilhas S) | Placas Base (Plaquitas S)

CS190501
290083600

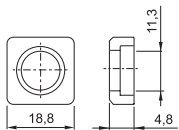

CS150500
290086100

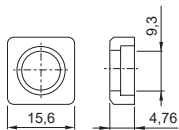

SHIMS (T SHAPES) | Colchões (Pastilhas T) | Placas Base (Plaquitas T)

CT160600
290083700

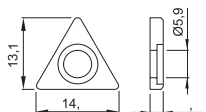

CT220500
290052700

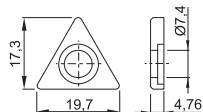

SHIMS (V SHAPES) | Colchões (Pastilhas V) | Placas Base (Plaquitas V)

CV160301
290054300

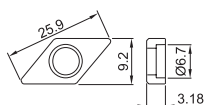

SHIMS (W SHAPES) | Colchões (Pastilhas W) | Placas Base (Plaquitas W)

CW080500
290053400

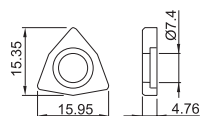
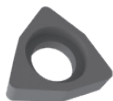

CW060302
290085700

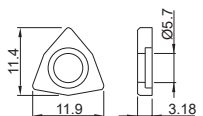

SPRINGS | Mola | Muelle

M06511
290070300

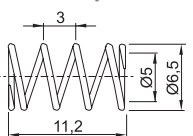

M09513
290054100

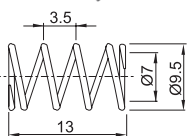

WRENCHES (ALLEN) | Chaves (Allen) | Llaves (Allen)

SS40
290021200
Allen 4



WRENCHES (TORX) | Chaves (Torx) | Llaves (Torx)

XT07
290012900
Torx 7



XT08
290011700
Torx 8





CAPTOS

NEW

HEADQUARTERS

PALBIT, S.A.

P.O.Box 4 - Palhal

3854-908 - Branca ALB - Portugal

T (+351) 234 540 300 | F (+351) 234 540 301

palbit@palbit.pt | www.palbit.pt

Branch office:

PALBIT México

Emerson 150. Int.803-804. Colonia Chapultepec

Morales Delagación Miguel Hidalgo

C.P. 11570 México DF

T (+52) 5555 454 543 | F (+52) 5552 509 190

info@palbit.com.mx | www.palbit.com.mx



SINCE 1916